

Wall Protection

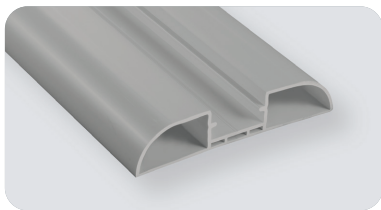

WP 100

Length **4.000 mm**
Packing **8 pz / box**
Colour **B E F**

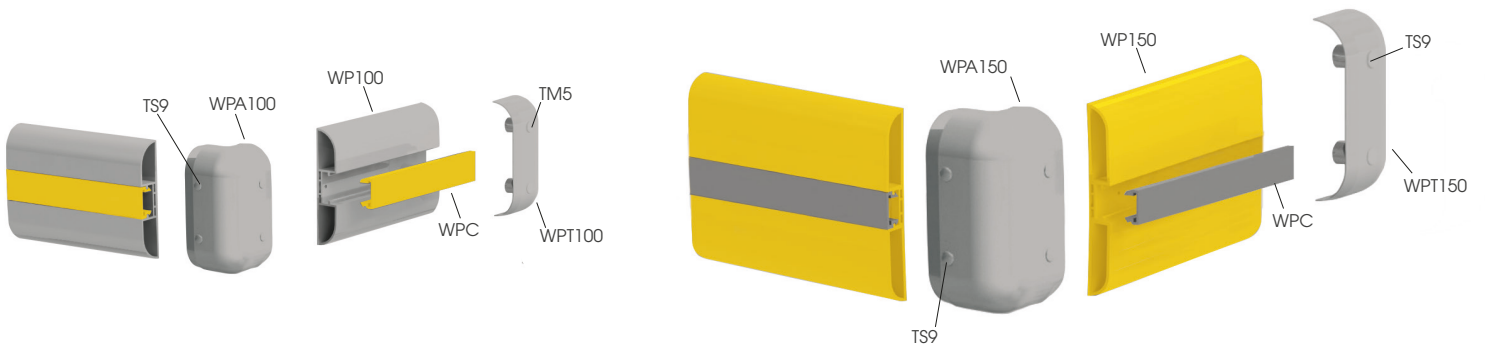
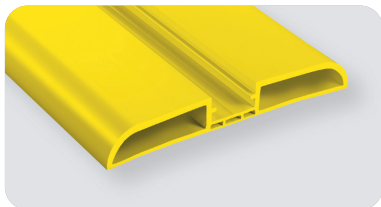
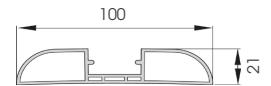

WP 150

Length **4.000 mm**
Packing **4 pz / box**
Colour **B M E**

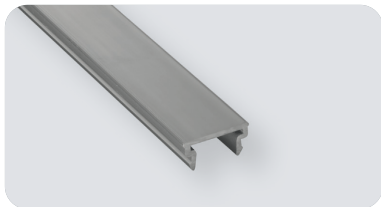
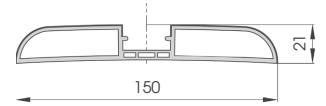

WPC

To install with WP 100 / WP 150

Length **4.000 mm**
Packing **16 pz / box**
Colour **A B M D E F G H**

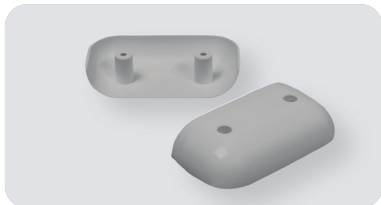
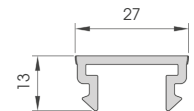

WPT 100

To install with TM5

Packing **50 pz / box**
Colour **B E F**

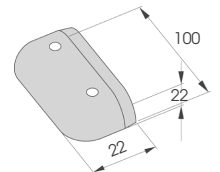

WPA 100

To install with TS9

Packing **20 pz / box**
Colour **B E**

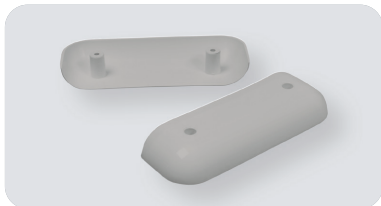
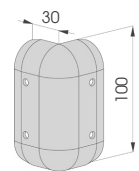

WPT 150

To install with TM5

Packing **50 pz / box**
Colour **B E**

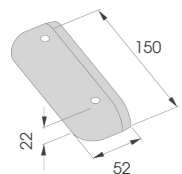

WPA 150

To install with TS9

Packing **20 pz / box**
Colour **B E**

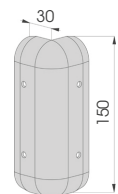

Wall Protection

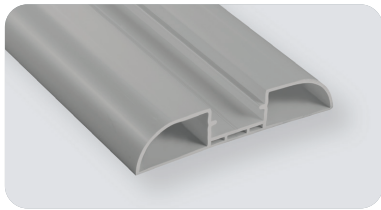
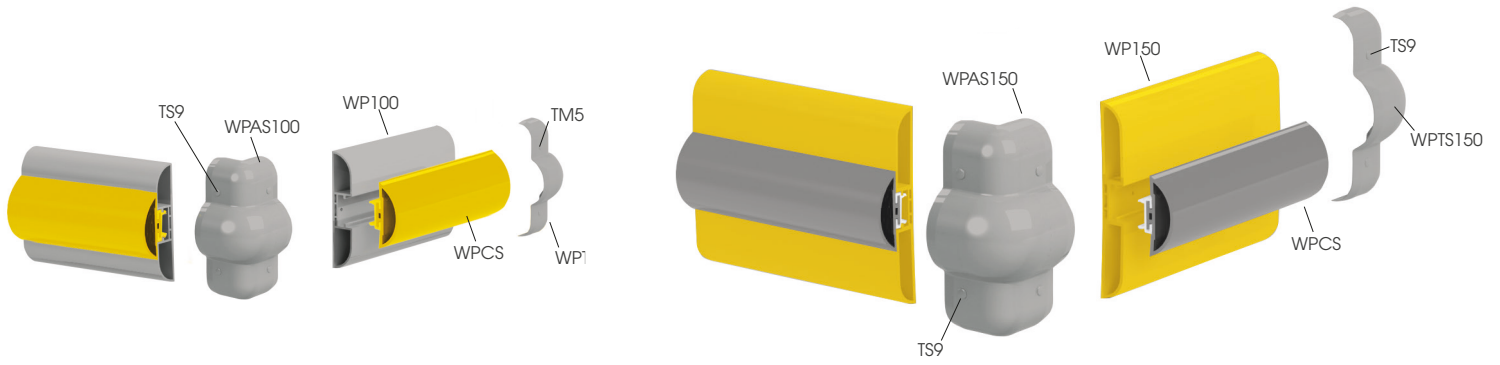

WP 100

Length **4.000 mm**
 Packing **8 pz / box**
 Colour **B E F**

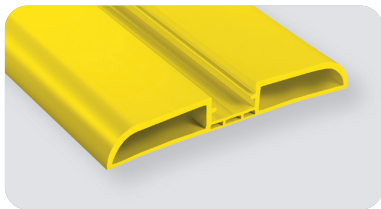
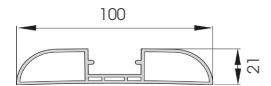

WP 150

Length **4.000 mm**
 Packing **4 pz / box**
 Colour **B M E**

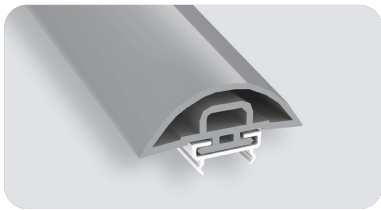
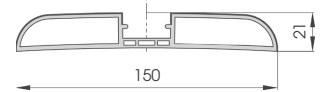

WPCS

To install with WP 100 / WP 150



Length **4.000 mm**
 Packing **8 pz / box**
 Colour **A B M D E F G H I**

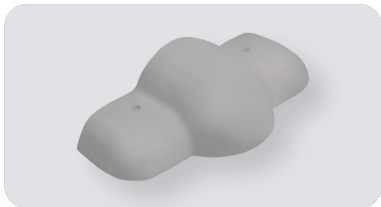
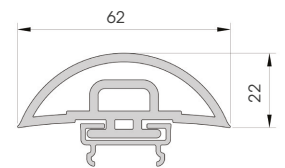

WPTS 100

To install with TS9

Packing **20 pz / box**
 Colour **B E**

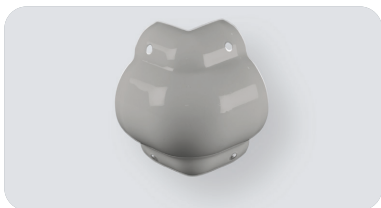
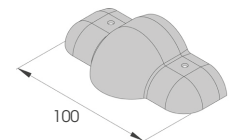

WPAS 100

To install with TS9

Packing **20 pz / box**
 Colour **B E**

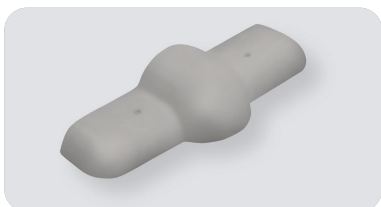
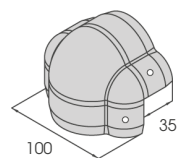

WPTS 150

To install with TS9

Packing **20 pz / box**
 Colour **B E**

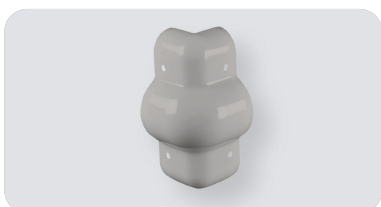
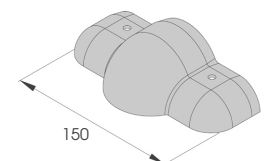

WPAS 150

To install with TS9

Packing **20 pz / box**
 Colour **B E**

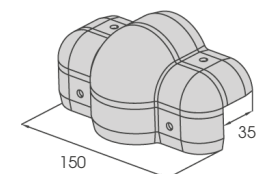

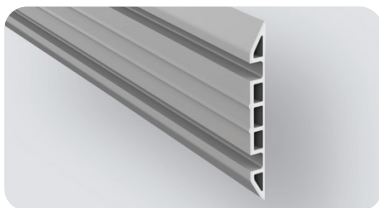
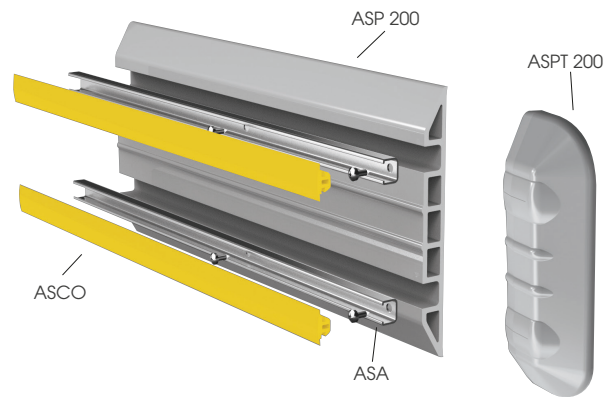

ASP 200



Length **4.000 mm**
 Packing **2 pz / box**
 Colour **B M**

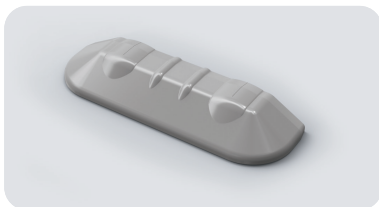
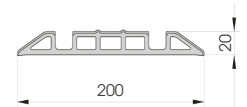

ASPT 200



Packing **10 pz / box**
 Colour **B D**

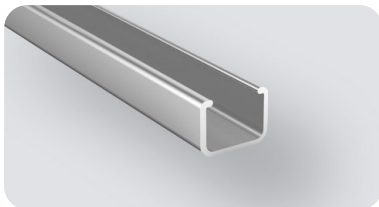
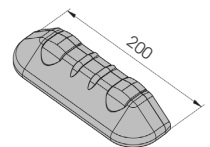

ASA

Material **aluminium**
 Length **4.000 mm**
 Packing **8 pz / bundle**

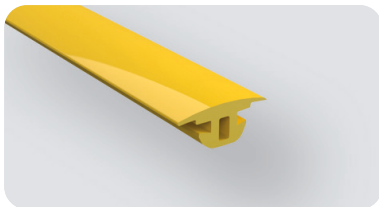
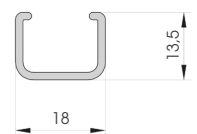

ASCO



Packing **2 pz / box**
 L = **32.000 mm**
 Colour **A B M D E**

