

LINK 150/2

BARRIERA DI SICUREZZA REGOLABILE
ADJUSTABLE SAFETY BARRIER

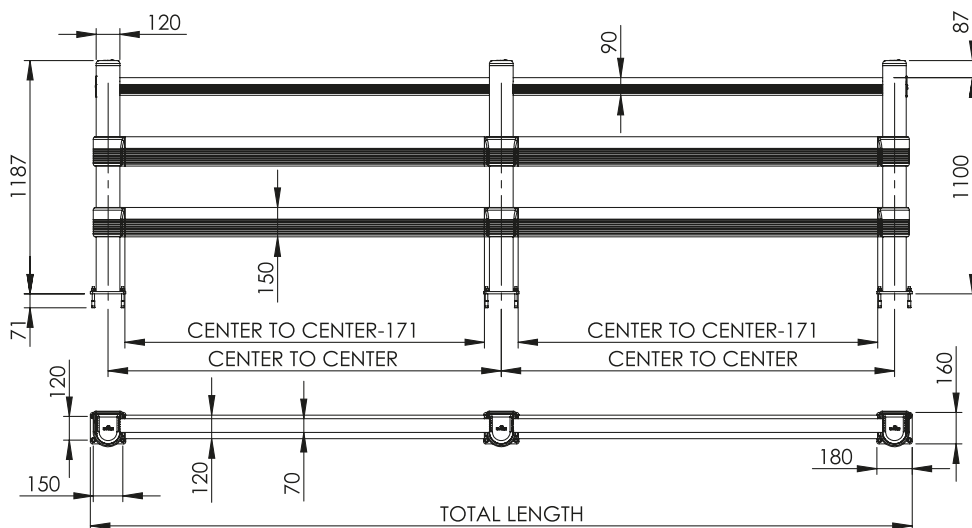
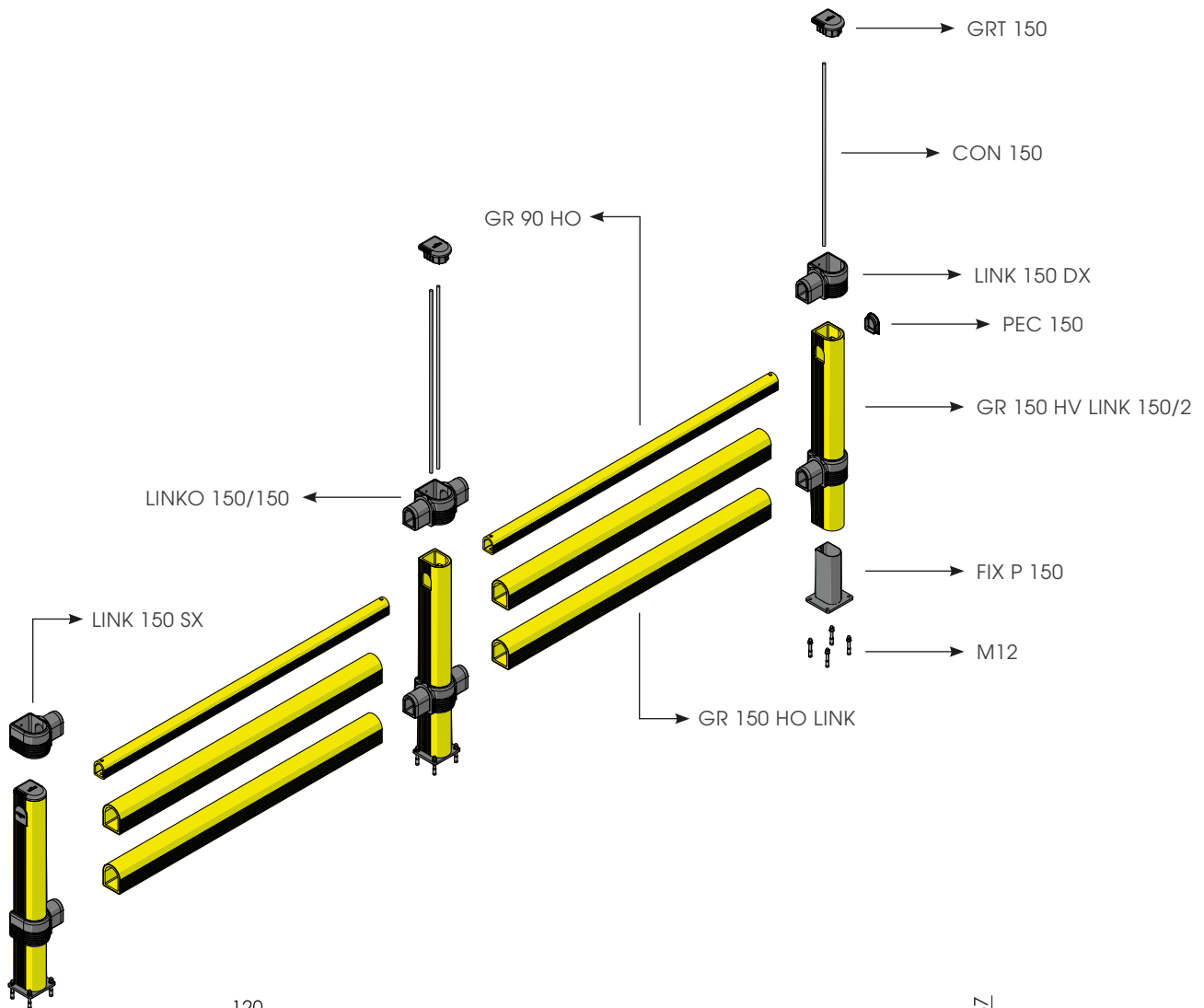

LINK 150/2

ISTRUZIONI DI INSTALLAZIONE
ASSEMBLY INSTRUCTIONS

LINK
CORNER

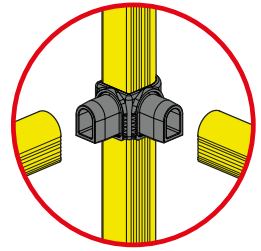

WARNING | The distance of installation depends on speed and weight of vehicle
The product is equipped with screws M8

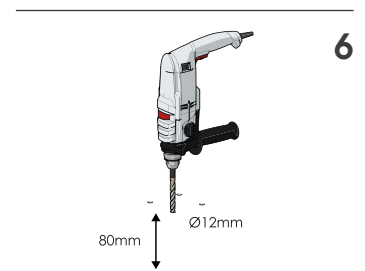
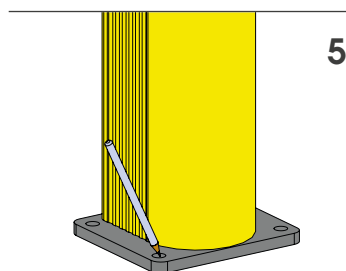
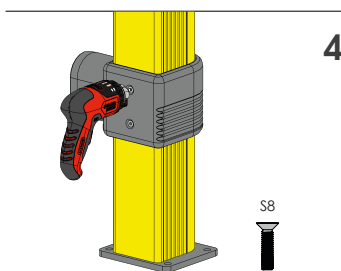
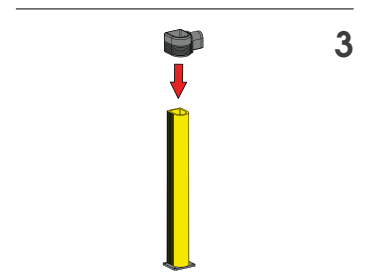
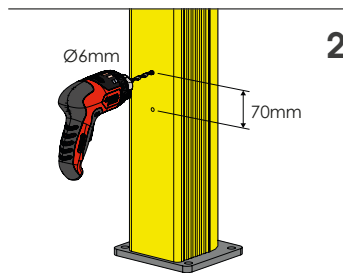
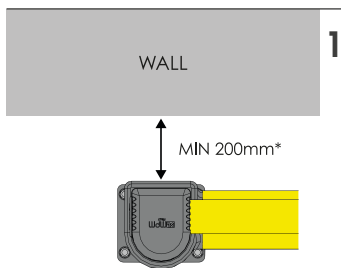
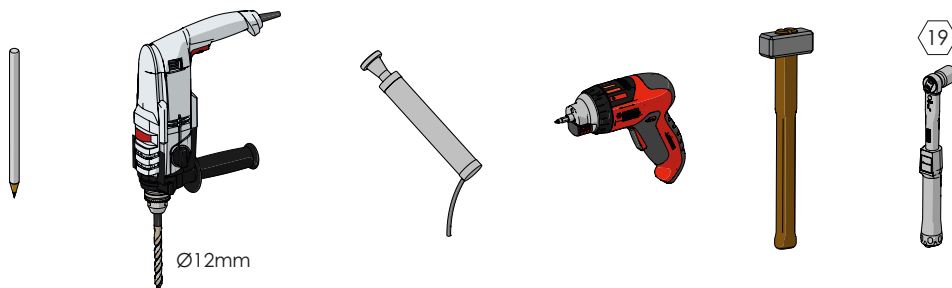

LINK 150/2

ISTRUZIONI DI INSTALLAZIONE
ASSEMBLY INSTRUCTIONS

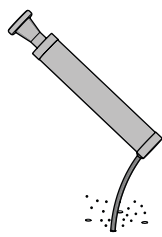

7

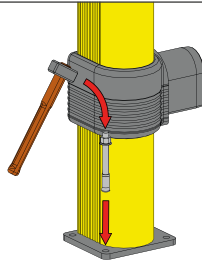

8

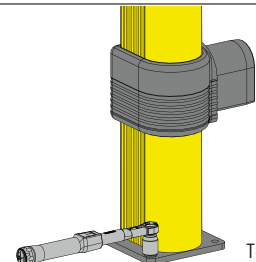

9

T=60Nm

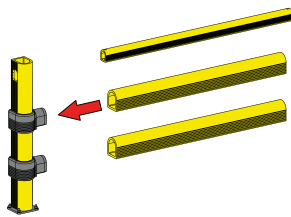

10

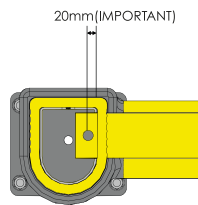

11

20mm (IMPORTANT)

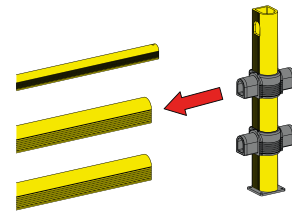

12

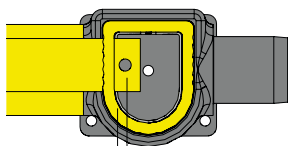

13

20mm (IMPORTANT)

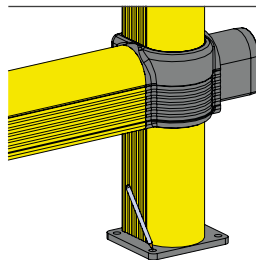

14

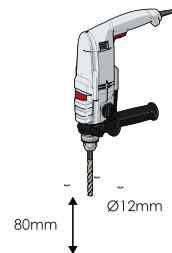

15

80mm

Ø12mm

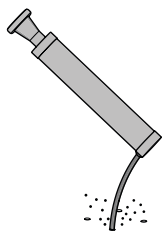

16

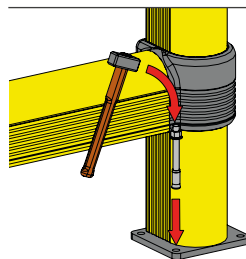

17

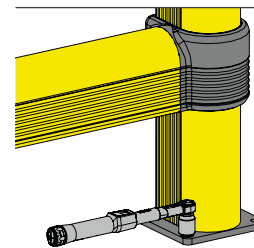

18

T=60Nm

LINK 150/2

ISTRUZIONI DI INSTALLAZIONE
ASSEMBLY INSTRUCTIONS

