

02. BOLLARD

GRD 90

PALO PROTEZIONE
BOLLARD

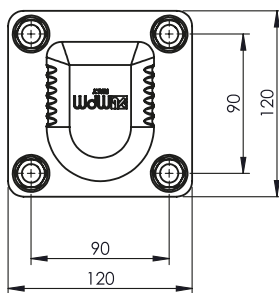
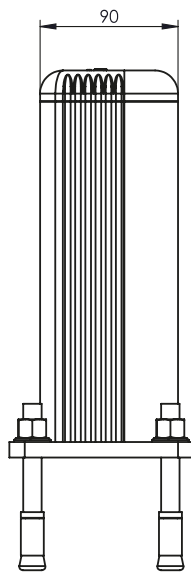
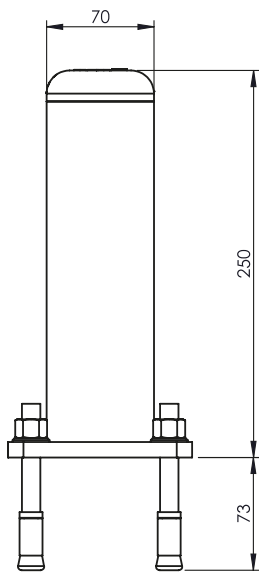

→ GRT 90

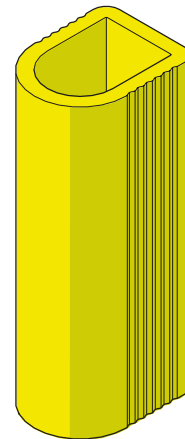

→ GR 90

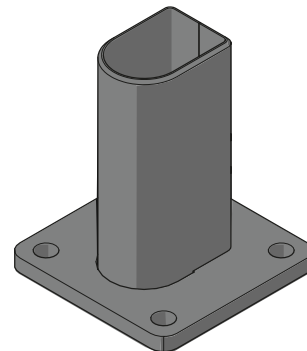

→ FIX P 90

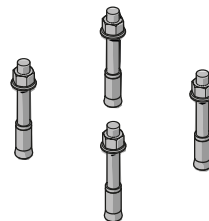

→ M12

GRD 90/150

ISTRUZIONI DI INSTALLAZIONE
ASSEMBLY INSTRUCTIONS

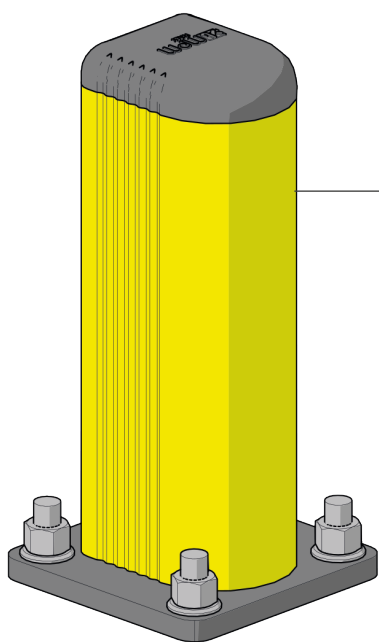

WARNING
The distance of installation depends on speed and weight of vehicle

