

### 03. GUARD RAIL

# GR 150

BARRIERA SINGOLA  
SINGLE-RAIL BARRIER

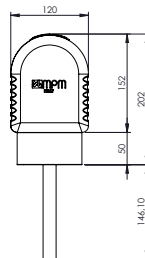
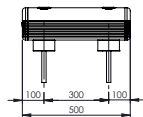
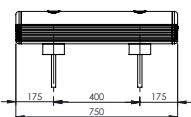
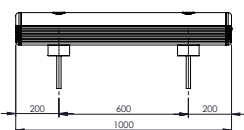
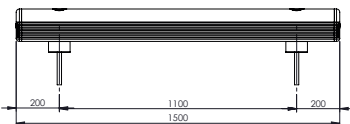
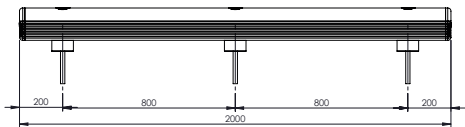
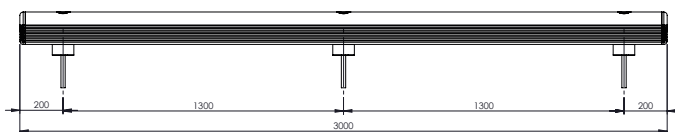
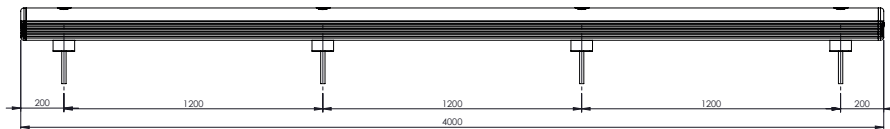
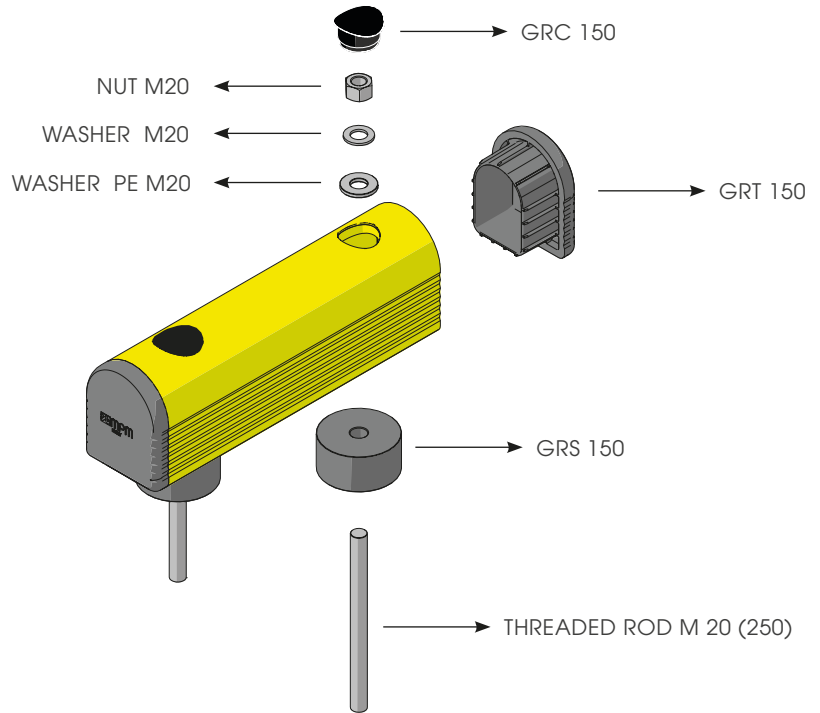

# GR 150

ISTRUZIONI DI INSTALLAZIONE  
ASSEMBLY INSTRUCTIONS



ONLY WITH RESIN

CHEMICAL ANCHOR

Ø24 mm

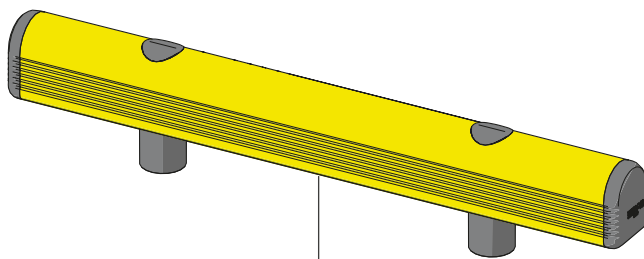

**WARNING**

The distance of installation depends on speed and weight of vehicle

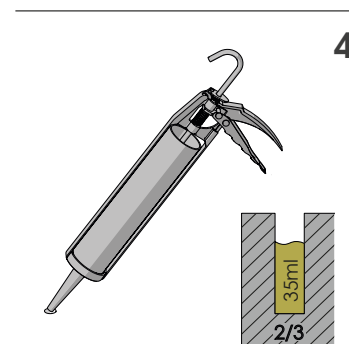
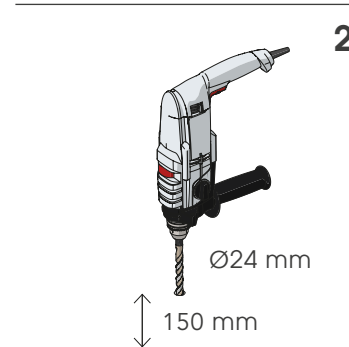
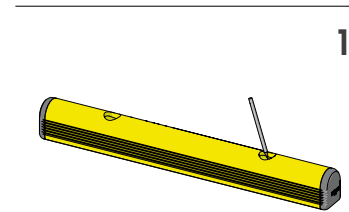
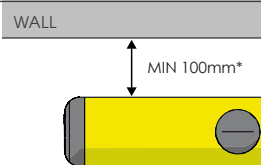

# GR 150

ISTRUZIONI DI INSTALLAZIONE  
ASSEMBLY INSTRUCTIONS



ONLY WITH RESIN

